

<http://clubhondaspirit.com/foro/topic/123885-alfombrillas-hechas-una-piltrafilla/page-13#entry2127575>

-Para hacerse una idea de la **ubicación de los agujeros para los tacos de los soportes:**

<http://www.s2ki.com/s2000/topic/848128-semi-gutted-interior-alcantara-door-panels/>





<http://www.s2ki.com/s2000/topic/217632-my-passenger-footwell-sub-install-lots-of-pics/>

Lado del pasajero:



**Brico:**

-Así es cómo tenía los soportes para las alfombrillas cortas. Menudo poco gusto a la hora de hacer los cortes y colocar los soportes!





-Alfombrillas de 4 piezas y sus soportes:















-Instrucciones de Montaje:

INSTALLATION INSTRUCTIONS

FLOOR CARPET MAT  
S2000

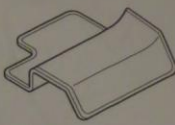
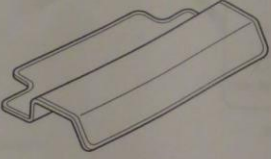
NOV. 2007

Parts List

Floor carpet mat (right)	Floor carpet mat (left)	Cover mat (right)
		
Cover mat (left)	Holders (4)	Screw grommets (4)
		
Self-tapping screws (4)		
		

Tools and Supplies Required

- Phillips screwdriver
- Utility Knife
- Scale
- Shop towel

© Honda Access Corp. 2007

08P16-S2A-6000-96

  
**HONDA** 1 / 6  
GENUINE ACCESSORIES

### Installation

1. Slide the passenger's seat to the rearmost completely.
2. Locate a slit on the floor mat and using an utility knife, cut on the floor mat from the slit as shown.

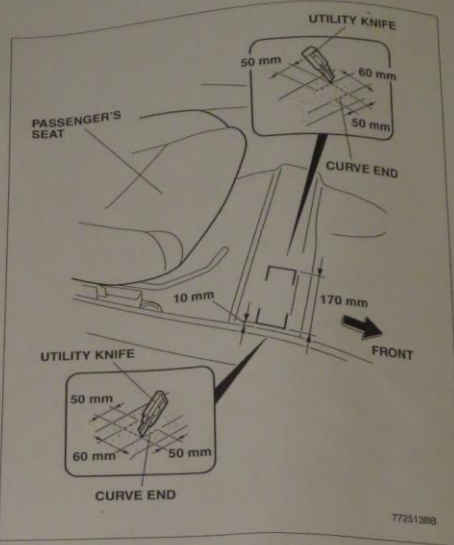

3. Peel off the part of the floor mat cut from step 2 and install a screw grommet into the square hole.

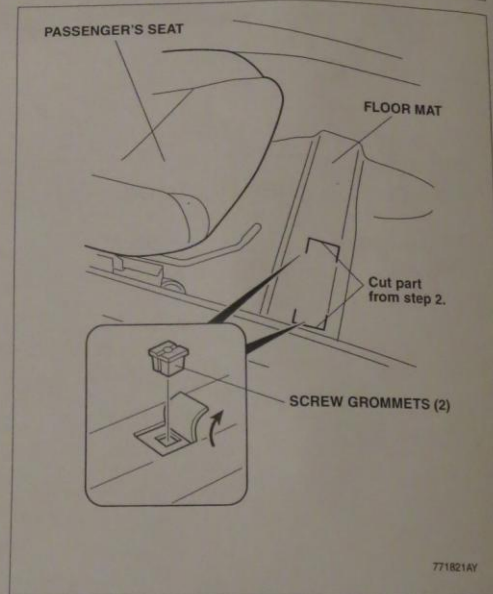

4. Slide the driver's seat to the rearmost completely.
5. Locate a slit on the floor mat and using an utility knife, cut on the floor mat from the slit as shown.

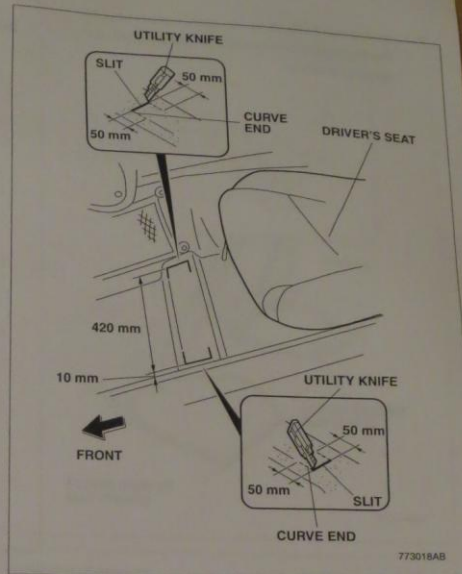

6. Peel off the part of the floor mat cut from step 4 and install a screw grommet into the square hole.

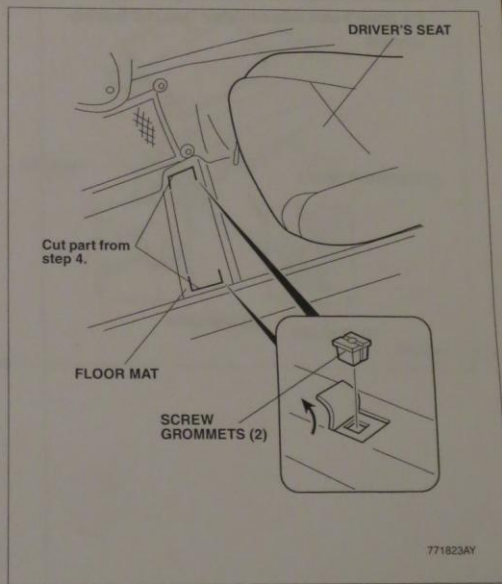

7. Install two holders to two screw grommets on the passenger's seat side as shown (two self-tapping screws).

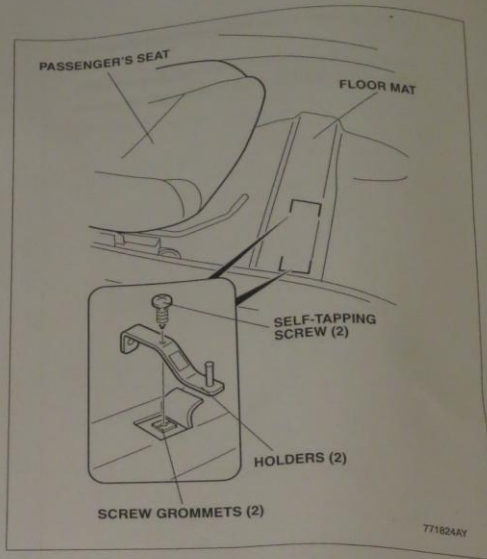

8. Install two holders to two screw grommets on the driver's seat side as shown (two self-tapping screws).

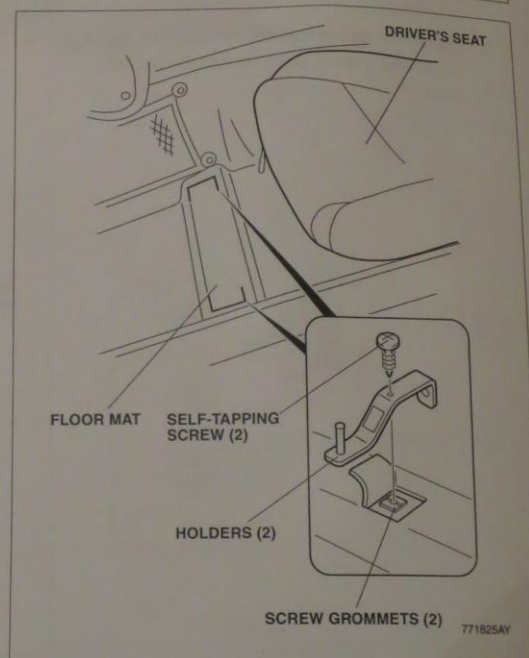

9. Install the floor carpet mat (right) to the floor mat on the passenger's seat side (two pins).
10. Install the floor carpet mat (left) to the floor mat on the driver's seat side (two pins).



11. Install the cover mat (right) onto the passenger's seat side holders (two magic fastener and two hooks).

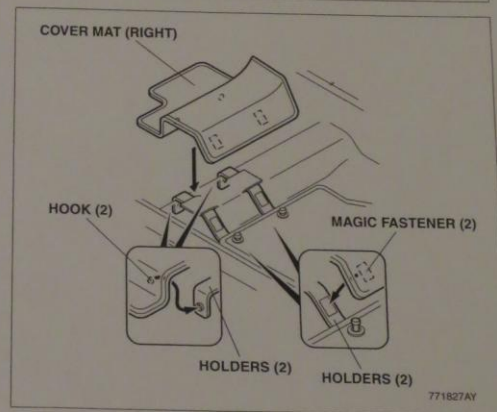

12. Install the cover mat (left) onto the driver's seat side holders (two magic fastener and two hooks).

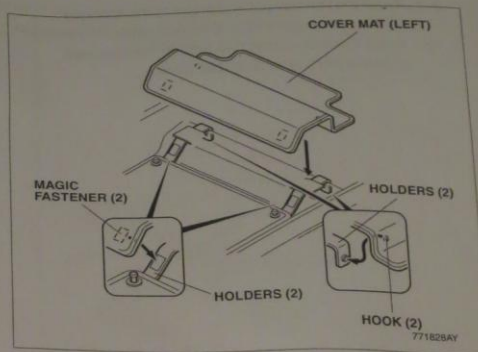

-Herramientas (aguja y punzón para tantear los agujeros, cola para volver a pegar la moqueta, cutter y destornillador):



-Tal y como comentaba Yayo (y, a pesar de lo que pone en las instrucciones), se trata de ubicar el agujero (presentar las moquetas con sus soportes también ayuda, tal y como decía NPulsar. Gracias!), cortar la moqueta lo suficiente como para poder meter el taco, dejar la moqueta lo mejor posible por encima de él y atornillar el tornillo en el taco (con la moqueta de por medio):











-Resultado:

